

## STANDARD EQUIPMENT

### ISO Standard cabin

All-weather steel cab with 360° visibility  
Safety glass windows  
Rise-up type windshield wiper  
Sliding fold-in front window  
Sliding side window(LH)  
Lockable door  
Hot & cool box  
Storage compartment & Ashtray  
Radio & USB player  
Handsfree mobile phone system with USB  
Transparent cabin roof-cover  
12 volt power outlet (24V DC to 12V DC converter)  
Sun visor

### Cabin ROPS(ISO 12117-2)

ROPS(Roll over protective structure)

### Computer aided power optimization (New CAPO) system

3-power mode, 2-work mode, User mode  
Auto deceleration & one-touch deceleration system  
Auto warm-up system  
Auto overheat prevention system

### Automatic climate control

Air conditioner & heater  
Defroster

### Self-diagnostics system

### Starting Aid (air grid heater) for cold weather

### Centralized monitoring

LCD display  
Engine speed or Trip meter/Accel.  
Clock  
Gauges  
Fuel level gauge  
Engine coolant temperature gauge  
Hyd. oil temperature gauge  
Warnings  
Check engine  
Overload  
Communication error  
Low battery  
Air cleaner clogging  
Indicators  
Max power  
Low speed/High speed  
Fuel warmer  
Auto idle

### Door and cab locks, one key

### Three outside rearview mirrors

### Mechanical suspension seat with heater

### Pilot-operated slidable joystick

### Console box height adjust system

### Four front working lights

### Electric horn

### Batteries (2 x 12V x 100 AH)

### Battery master switch

### Removable clean-out dust net for cooler

### Automatic swing brake

### Removable reservoir tank

### Fuel pre-filter with fuel warmer

### Boom holding system

### Arm holding system

### Track shoes (600mm, 24")

### Track rail guard

### Accumulator for lowering work equipment

### Electric transducer

### Lower frame under cover (Normal)

### Viscous fan clutch

## OPTIONAL EQUIPMENT

### Fuel filler pump (50 L/min)

### Beacon lamp

### Safety lock valve for boom cylinder with overload warning device

### Safety lock valve for arm cylinder

### Single-acting piping kit (breaker, etc.)

### Double-acting piping kit (clamshell, etc.)

### Quick coupler

### Travel alarm

### Boom

5.68 m, 18' 8"

### Arms

2.00 m, 6' 7"

2.40 m, 7' 10"

2.92 m, 9' 7"

### Cabin lights

### Cabin front window rain guard

### Track shoes

700mm, 28"

800mm, 32"

900mm, 36"

### Lower frame under cover (Additional)

### Long crawler lower frame

### Long crawler & Front dozer lower frame

### Tool kit

### Rearview camera

### Pattern change valve (2 patterns)

### Hi-mate (Remote Management System)

### Cabin FOPS/FOG (ISO/DIS 10262)-Level II

FOPS (Falling Object Protective Structure)

FOG (Falling Object Guard)

\* Standard and optional equipment may vary. Contact your Hyundai dealer for more information. The machine may vary according to International standards.

\* The photos may include attachments and optional equipment that are not available in your area.

\* Materials and specifications are subject to change without advance notice.

\* All imperial measurements rounded off to the nearest pound or inch.

### PLEASE CONTACT



6100 Atlantic Blvd, Norcross, GA 30071

TEL (678) 823-7777 FAX (678) 823-7778

**Robex**

# 235LCR-9A

With Tier 4 Interim Engine installed

MOVING YOU FURTHER

**HYUNDAI HEAVY INDUSTRIES**



\*Photo may include optional equipment



**HYUNDAI**  
CONSTRUCTION EQUIPMENT AMERICAS, INC.

# PRIDE AT WORK

Hyundai Heavy Industries strives to build state-of-the-art earthmoving equipment to give every operator maximum performance, more precision, versatile machine preferences, and proven quality.

***Take pride in your work with Hyundai!***



# Robex 235LCR-9A

## Machine Walk-Around

### Engine Technology

Proven, reliable, fuel efficient, low emission and low noise  
Cummins Tier 4 interim & EU stage III B engine

### Hydraulic System Improvements

New patented hydraulic control for improved controllability / Improved control valve design for added efficiency and smoother operation / New auto boom and swing priority system for optimum speed / New auto power boost feature for additional power when needed / Improved arm-in and boom-down flow regeneration system for added speed and efficiency

### Pump Compartment

Industry-leading, powerful, reliable Kawasaki designed, variable volume in-line axial piston pumps  
New compact solenoid block equipped with 4 solenoid valves, 1 EPPR valve, 1 check valve accumulator and pilot filter - controls 2 speed travel, power boost, boom priority, safety lock, arm regeneration

### Enhanced Operator Cab

#### Improved Visibility

Enlarged cab with improved visibility / See-through upper skylight for visibility and ventilation  
Larger right-side glass, now one piece, for better right visibility  
Safety glass windows on all sides - less expensive than (polycarbonate) and won't scratch or fade  
Closeable sunshade for operator convenience / Reduced front window seam for improved operator view

#### Improved Cab Construction

New steel tube construction for added operator safety, protection and durability  
New window open/close mechanism designed with cable and spring lift assist and single latch release

#### Improved Suspension Seat / Console Assembly

Ergonomic joysticks with auxiliary control buttons for attachment use. Now with new sleek styling  
Heated suspension (standard)

#### Advanced 7" Color Cluster with Touch Screen

New Color LCD Display with easy to read digital gauges for hydraulic oil temperature, water temperature, and fuel. Simplified design makes adjustment and diagnostics easier. Also, new enhanced features such as rear-view camera are integrated into monitor.

3 power modes : (P) Power, (S) Standard, (E) Economy, 2 work modes : Dig & Attachment, (U) User mode for operator preference

Enhanced self-diagnostic features with GPS download capability

One pump flow or two pump flow for optional attachment is now selectable through the cluster / New anti-theft system with password capability

Boom speed and arm regeneration are selectable through the monitor.

Auto power boost is now available - selectable (on/off) through the monitor.

Powerful air conditioning and heat with auto climate control

RMS (Remote Management System) works through GPS/satellite technology to ultimately provide better customer service and support.

### Undercarriage

Sealed track chain (urethane seals) / Standard track rail guard / Comfortable bolt-on steps

Large upper roller cut-outs for debris clean-out / Tapered side frames for debris clean-out / Grease-type track tensioner

\*Photo may include optional equipment.

# PRECISION

Innovative hydraulic system technologies make the 9A series excavator fast, smooth and easy to control.



\*Photo may include optional equipment.

## Computer Aided Power

The engine horsepower and hydraulic horsepower together in unison through the advanced CAPO(Computer Aided Power Optimization) system, flow for the job at hand. Operator can set their own preferences for boom or swing priority, power mode selection and optional work tools at the touch of a button.

The CAPO system also provides complete self diagnostic features and digital gauges for important information like hydraulic oil temperature, water temperatures and fuel level. This system interfaces with multiple sensors placed throughout the hydraulic system as well as the electronically controlled engine to provide the optimum level of engine power and hydraulic flow.

### Power Mode

P (Power Max) mode maximizes machine speed and power for mass production. S (Standard) mode provides a reduced, fixed rpm for optimum performance and improved fuel economy. For maximum fuel savings and improved control, E (Economy) mode provides precise flow and engine power based on load demand. Three unique power modes provide the operator with custom power, speed and fuel economy.

### Work Mode

The work mode allows the operator to select single flow attachments like a hydraulic breaker or bi-directional flow attachments like a crusher. Flow settings unique to each attachment can be programmed from within the cluster.

### User Mode

Some jobs require more precise machine settings. Using the versatile U (User) mode, the operator can customize engine speed, pump output, idle speed and other machine settings for the job at hand.

## Improved Hydraulic System



To achieve optimum precision, Hyundai redesigned the hydraulic system to provide the operator with super fine touch and improved controllability. Improved pump flow control reduces flow when controls are not being used to minimize fuel consumption.

Improved spool valves in the control valve are engineered to provide more precise flow to each function with less effort.

Improved hydraulic valves, precision-designed variable volume piston pumps, fine-touch pilot controls, and enhanced travel functions make any operator running a

9A series look like a smooth operator. Newly improved features include arm-in and boom-down flow regeneration, improved control valve technology and innovative auto boom and swing priority for optimal performance in any application.

### Auto Boom-swing Priority

This smart function automatically and continuously looks the ideal hydraulic flow balance for the boom and swing motions of the machine. The advanced CAPO system monitors the hydraulic system and adjusts its settings to maximize performance and productivity.



# PERFORMANCE

9A series is designed for maximum performance to keep the operator working productively.



\*Photo may include optional equipment.

## Track Rail Guard & Adjusters

Durable track rail guards keep track links in place. Track adjustment is made easy with standard grease cylinder track adjusters and shock absorbing springs.

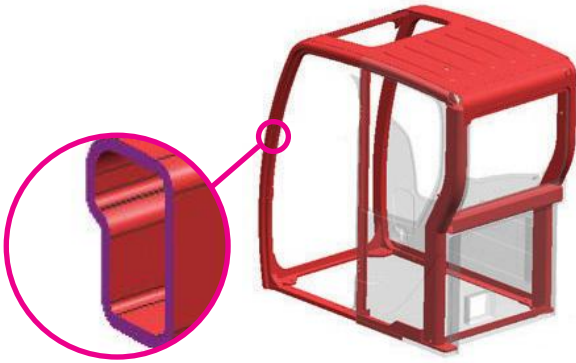

## Structure Strength

The 9A series cabin structure has been fitted with stronger but slimmer tubing for more safety and improved visibility. Low-stress, high strength steel is integrally welded to form a stronger, more durable upper and lower frame. Structural integrity was tested by way of FEM (Finite Elements Method) analysis and long-term durability tests. The ROPS(Roll Over Protective Structure) cab can be equipped to enhance operator safety.

## Eco-friendly Cummins QSB 6.7 Engine

The CUMMINS QSB6.7 engine combines advanced electronic controls and a self-diagnostic system with reliable performance. The combination of a high pressure common rail system and an advanced in-cylinder combustion technology results in increased power, improved transient response and reduced fuel consumption. The QSB6.7 Cummins engine complies with current emissions standards including EPA Tier4 Interim and EU Stage III-B.

## The Definition of Progress

The Quantum System B Series 6.7-liter engine combines full authority electronic controls with the reliable performance. The electronics with the QSB6.7 have been proven with our high-horse power products-working in the harshest, most demanding environments-search as dusty, non-stop mining operations while meeting emissions regulations worldwide.

The QSB6.7 features 24 valve designed with centered injectors and symmetrical piston bowl. The combination of improved air flow and evenly dispersed fuel results in increased power, improved transient reponse and reduced fuel consumption.





# PREFERENCE

Operating a 9A series is unique to every operator. Operators can fully customize their work environment and operating preferences to fit their individual needs.



\*Photo may include optional equipment.



## Wide Cabin with Excellent Visibility

The newly designed cabin was conceived for more space, a wider field of view and operator comfort. Special attention was given to a clear, open and convenient interior with plenty of visibility on the machine surroundings and the job at hand. This well balanced combination of precision aspects put the operator in the perfect position to work safely and securely.

## Operator Comfort

In the 9A series cabin you can easily adjust the seat, console and armrest settings to best suit your personal operating preferences. Seat and console position can be set together and independent from each other. Additional creature comforts include the fully automatic high-capacity airconditioning system and the radio / USB player.



## Reduced Stress

Work is stressful enough. Your work environment should be stress free. Hyundai's 9A series provides improved cab amenities, additional space and a comfortable seat to minimize stress to the operator. A powerful climate control system provides the operator with optimum air temperature. An advanced audio system with USB player, AM/FM stereo and MP3 capabilities, plus remotely located controls is perfect for listening to music favorites. Operators can even talk on the phone with the hands-free cell phone feature. Also, the newly designed optional remote control offers mobile bluetooth-handsfree and radio cable-handsfree function.



## Smart Key System (Option)

9A series excavators provide smart key system as an option. This allows the operator to start the engine by the push of a starter button without inserting a key in the ignition.



## Operator - Friendly Cluster

The advanced new cluster with 7 inch wide color LCD with touch screen and toggle switch allows the operator to select his personal machine preferences. Power and work mode selection, self diagnostics, optional rear-view camera, maintenance check lists, start-up machine security, and video functions were integrated into the cluster to make the machine more versatile and the operator more productive.

The newly applied FM transmitter application transmits signal to USB & Radio player with the same frequency as cluster. The player outputs the audio through the internal speaker in the cab. The video & firmware updates are possible with USB host support and an adjustable cluster hinge bracket improves cluster visibility.

## Monitor Tilt Range



**Horizontal**  
Total : 15°



**Vertical**  
Total : 30°



# PROFITABILITY

9A series is designed to maximize profitability through improved efficiencies, enhanced service features and longer life components.



\*Photo may include optional equipment.

## Fuel Efficiency

9A series excavators are engineered to be extremely fuel efficient. New innovations like two-stage auto decel system and the new economy mode help to conserve fuel and reduce the impact on the environment.



### Hi-mate (Remote Management System)

Hi-mate, Hyundai's proprietary remote management system, provides operators and dealer service personnel access to vital service and diagnostic information on the machine from any computer with internet access. Users can pinpoint machine location using digital mapping and set machine work boundaries, reducing the need for multiple service calls. Hi-mate saves time and money for the owner and dealer by promoting preventative maintenance and reducing machine downtime.



### Easy Access

Ground-line access to filters, lube fittings, fuses, machine computer components and wide open compartments makes service more convenient on the 9A series.



## Long-Life Components

9A series excavators were designed with bushings designed for long-life lube intervals (250 hrs) & polymer shims (wear resistant, noise reducing), long-life hydraulic filters (1,000hrs), long-life hydraulic oil (5,000hrs), more efficient cooling systems and integrated preheating systems which extend service intervals, minimize operating costs and reduce machine down time.

# Specifications

## ENGINE

MODEL	CUMMINS QSB6.7 Engine		
Type	Water cooled, 4 cycle Diesel, 6-cylinders in line, direct injection, turbocharged charger and air cooled		
Rated flywheel horse power	SAE	J1995 (gross)	167HP (124kW)/ 1,950 rpm
		J1349 (net)	157HP (117kW)/ 1,950 rpm
	DIN	6271/1 (gross)	169PS (124kW)/ 1,950 rpm
		6271/1 (net)	159PS (117kW)/ 1,950 rpm
Max. torque	74.7kgf-m (540lb-ft)/1,500rpm		
Bore X stroke	107mm X 124mm (4.2" X 4.9")		
Piston displacement	6,700cc (409 in <sup>3</sup> )		
Batteries	2 X 12V X 100AH		
Starting motor	24V, 4.8kW		
Alternator	24V, 95Amp		

## HYDRAULIC SYSTEM

MAIN PUMP	
Type	Variable displacement tandem axis piston pumps
Rated flow	2 X 228.2 L/min (60.3 US gpm/50.2 UK gpm)
Sub-pump for pilot circuit	Gear pump

Cross-sensing and fuel saving pump system.

HYDRAULIC MOTORS	
Travel	Two speed axial pistons motor with brake valve and parking brake
Swing	Axial piston motor with automatic brake

RELIEF VALVE SETTING	
Implement circuits	350 kgf/cm <sup>2</sup> (4,980 psi)
Travel	350 kgf/cm <sup>2</sup> (4,980 psi)
Power boost (boom, arm, bucket)	380 kgf/cm <sup>2</sup> (5,410 psi)
Swing circuit	285 kgf/cm <sup>2</sup> (4,050 psi)
Pilot circuit	40 kgf/cm <sup>2</sup> (570 psi)
Service valve	Installed

HYDRAULIC CYLINDERS	
No. of cylinder bore X stroke	Boom: 2-120 X 1,290 mm (4.7" X 50.8")
	Arm: 1-140 X 1,510 mm (5.5" X 59.4")
	Bucket: 1-120 X 1,055 mm (4.7" X 41.5")

## DRIVES & BRAKES

Drive method	Fully hydrostatic type
Drive motor	Axial piston motor, in-shoe design
Reduction system	Planetary reduction gear
Max. drawbar pull	21,400 kgf (47,180 lbf)
Max. travel speed(high) / (low)	5.8 km/hr (3.6mph) / 3.4 km/hr (2.1mph)
Gradeability	30° (58 %)
Parking brake	Multi wet disc

## CONTROL

Pilot pressure operated joysticks and pedals with detachable lever provide almost effortless and fatigueless operation.

Pilot control	Two joysticks with one safety lever (LH): Swing and arm, (RH): Boom and bucket(ISO)
Traveling and steering	Two levers with pedals
Engine throttle	Electric, Dial type

## SWING SYSTEM

Swing motor	Fixed displacement axial piston motor
Swing reduction	Planetary gear reduction
Swing bearing lubrication	Grease-bathed
Swing brake	Multi wet disc
Swing speed	10.7 rpm

## COOLANT & LUBRICANT CAPACITY

Refilling	liter	US gal	UK gal
Fuel tank	320	84.5	70.4
Engine coolant	38	10	8.4
Engine oil	23.7	6.3	5.2
Swing device-gear oil	6.2	1.6	1.4
Final drive(each)-gear oil	6	1.6	1.3
Hydraulic system(including tank)	275	72.6	60.5
Hydraulic tank	160	42.3	35.2

## UNDERCARRIAGE

The X-leg type center frame is integrally welded with reinforced box-section track frames. The undercarriage includes lubricated rollers, idlers, track adjusters with shock absorbing springs and sprockets, and a track chain with double or triple grouser shoes.

Center frame	X - leg type
Track frame	Pentagonal box type
No. of shoes on each side	49 EA
No. of carrier roller on each side	2 EA
No. of track roller on each side	9 EA
No. of rail guard on each side	2 EA

## OPERATING WEIGHT (APPROXIMATE)

Operating weight, including 5,680mm (18' 8") boom, 2,920mm (9' 7") arm, SAE heaped 0.80m<sup>3</sup> (1.05 yd<sup>3</sup>) bucket, lubricant, coolant, full fuel tank, full hydraulic tank, and all standard equipments.

MAJOR COMPONENT WEIGHT	
Upperstructure	5,600 kg (12,350 lb)
Boom(with arm cylinder)	1,950 kg (4,300 lb)
Arm(with bucket cylinder)	1,095 kg (2,410 lb)

OPERATING WEIGHT			
Shoes		Operating weight	Ground pressure
Type	Width mm(in)	kg(lb)	kgf/cm <sup>2</sup> (psi)
Triple grouser	600 (24")	23,800 (52,470)	0.51 (7.25)
	700 (28")	24,060 (53,040)	0.44 (6.26)
	800 (32")	24,320 (53,620)	0.39 (5.55)
	900 (36")	24,580 (54,190)	0.35 (4.98)

## BUCKETS

All buckets are welded with high-strength steel.



SAE  
heaped  
m<sup>3</sup> (yd<sup>3</sup>)



0.80 (1.05)  
0.87 (1.14)  
0.92 (1.20)



1.10 (1.44)  
1.20 (1.57)

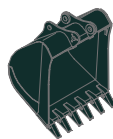

1.34 (1.75)



\* 0.74 (0.97)  
\* 0.90 (1.18)  
\* 1.05 (1.37)



● 0.87 (1.14)

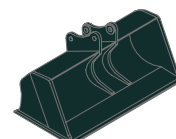

■ 0.75 (0.98)

Capacity m <sup>3</sup> (yd <sup>3</sup> )		Width mm (in)		Weight kg (lb)	Recommendation mm (ft-in)		
SAE heaped	CECE heaped	Without side cutters	With side cutters		5,680 (18' 8") Boom		
				2,000 (6' 7") Arm		2,400 (7' 10") Arm	2,920 (9' 7") Arm
0.51 (0.67)	0.45 (0.59)	700 (27.6)	820 (32.3)	570 (1,260)	●	●	●
0.80 (1.05)	0.70 (0.92)	1,000 (39.4)	1,120 (44.1)	700 (1,540)	●	●	●
0.87 (1.14)	0.75 (0.98)	1,090 (42.9)	1,210 (47.6)	740 (1,630)	●	●	■
0.92 (1.20)	0.80 (1.05)	1,150 (45.3)	1,270 (50.0)	770 (1,700)	●	●	■
1.10 (1.44)	0.96 (1.26)	1,320 (52.0)	1,440 (56.7)	830 (1,830)	●	■	▲
1.20 (1.57)	1.00 (1.31)	1,400 (55.1)	1,520 (59.8)	850 (1,870)	■	▲	-
1.34 (1.75)	1.15 (1.50)	1,550 (61.0)	1,670 (65.7)	920 (2,030)	▲	▲	-
* 0.74 (0.97)	0.65 (0.85)	985 (38.8)	-	770 (1,700)	●	●	●
* 0.90 (1.18)	0.80 (1.05)	1,070 (42.1)	-	810 (1,790)	●	●	■
* 1.05 (1.37)	0.92 (1.20)	1,290 (50.8)	-	890 (1,960)	●	■	▲
● 0.87 (1.14)	0.75 (0.98)	1,140 (44.9)	-	900 (1,980)	●	●	■
■ 0.75 (0.98)	0.65 (0.85)	1,790 (70.5)	-	880 (1,940)	●	●	■

\* Heavy duty bucket

■ Slope finishing bucket

● Rock-Heavy duty bucket

●: Applicable for materials with density of 2,000 kg/m<sup>3</sup> (3,370 lb/ yd<sup>3</sup>) or less

■: Applicable for materials with density of 1,600 kg/m<sup>3</sup> (2,700 lb/ yd<sup>3</sup>) or less

▲: Applicable for materials with density of 1,100 kg/m<sup>3</sup> (1,850 lb/ yd<sup>3</sup>) or less

## ATTACHMENT

Booms and arms are welded with a low-stress, full-box section design. 5.68m Boom and 2.0m, 2.4m, 2.92m Arms are available.

## DIGGING FORCE

Boom	Length	mm (ft-in)	5,680 (18' 8")			Remarks
	Weight	kg (lb)	1,950 (4,300)			
Arm	Length	mm (ft-in)	2,000 (6' 7")	2,400 (7' 10")	2,920 (9' 7")	[ ]: Power Boost
	Weight	kg (lb)	975 (2,150)	1,045 (2,300)	1,095 (2,410)	
Bucket digging force	SAE	kN	133.4 [144.8]	133.4 [144.8]	133.4 [144.8]	
		kgf	13600 [14770]	13600 [14770]	13600 [14770]	
		lbf	29980 [32550]	29980 [32550]	29980 [32550]	
	ISO	kN	152.0 [165.0]	152.0 [165.0]	152.0 [165.0]	
		kgf	15500 [16830]	15500 [16830]	15500 [16830]	
		lbf	34170 [37100]	34170 [37100]	34170 [37100]	
Arm crowd force	SAE	kN	144.2 [156.5]	119.6 [129.9]	102.0 [110.7]	
		kgf	14700 [15960]	12200 [13250]	10400 [11290]	
		lbf	32410 [35190]	26900 [29210]	22930 [24900]	
	ISO	kN	151.0 [164.0]	125.5 [136.3]	106.9 [116.1]	
		kgf	15400 [16720]	12800 [13900]	10900 [11830]	
		lbf	33950 [36860]	28220 [30640]	24030 [26090]	

Note: Boom weight includes arm cylinder, piping, and pin

Arm weight includes bucket cylinder, linkage, and pin

# Dimensions & Working Range

## R235LCR-9A DIMENSIONS

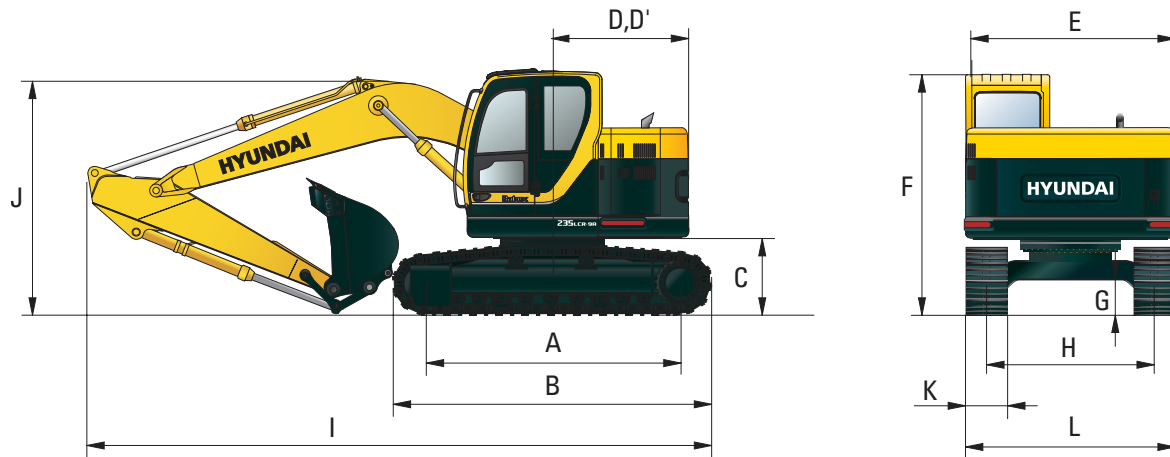

mm (ft-in)

A Tumbler distance	3,650 (11' 12")	Boom length	5,680 (18' 8")			
B Overall length of crawler	4,440 (14' 7")	Arm length	2,000 (6' 7")	2,400 (7' 10")	2,920 (9' 7")	
C Ground clearance of counterweight	1,060 (3' 6")	I Overall length	9,040 (29' 8")	8,950 (29' 4")	8,910 (29' 3")	
D Tail swing radius	1,780 (6' 04")	J Overall height of boom	3,200 (10' 6")	3,100 (10' 2")	3,020 (9' 11")	
D' Rear-end length	1,780 (6' 04")	K Track shoe width	600 (24")	700 (28")	800 (32")	900 (36")
E Overall width of upperstructure	2,980 (9' 9")	L Overall width	2,990 (9' 10")	3,090 (10' 2")	3,190 (10' 6")	3,290 (10' 10")
F Overall height of cab	2,950 (9' 8")					
G Min. ground clearance	480 (1' 7")					
H Track gauge	2,390 (7' 10")					

## R235LCR-9A WORKING RANGE

mm (ft-in)

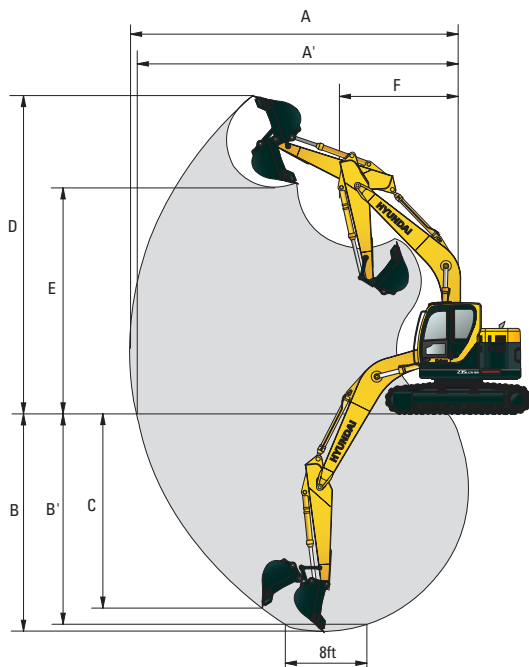

Boom length	5,680 (18' 8")		
Arm length	2,000 (6' 7")	2,400 (7' 10")	2,920 (9' 7")
A Max. digging reach	9,040 (29' 8")	9,430 (30' 11")	9,910 (32' 6")
A' Max. digging reach on ground	8,860 (29' 1")	9,260 (30' 5")	9,750 (31' 12")
B Max. digging depth	5,780 (18' 12")	6,180 (20' 3")	6,700 (21' 12")
B' Max. digging depth (8' level)	5,550 (18' 3")	5,980 (19' 7")	6,530 (21' 5")
C Max. vertical wall digging depth	5,140 (16' 10")	5,710 (18' 9")	6,270 (20' 7")
D Max. digging height	10,090 (33' 1")	10,420 (34' 2")	10,830 (35' 6")
E Max. dumping height	7,190 (23' 7")	7,510 (24' 8")	7,890 (25' 11")
F Min. swing radius	2,860 (9' 5")	2,550 (8' 4")	2,350 (7' 9")

# Dimensions & Working Range

## R235LCR-9A (DOZER TYPE) DIMENSIONS

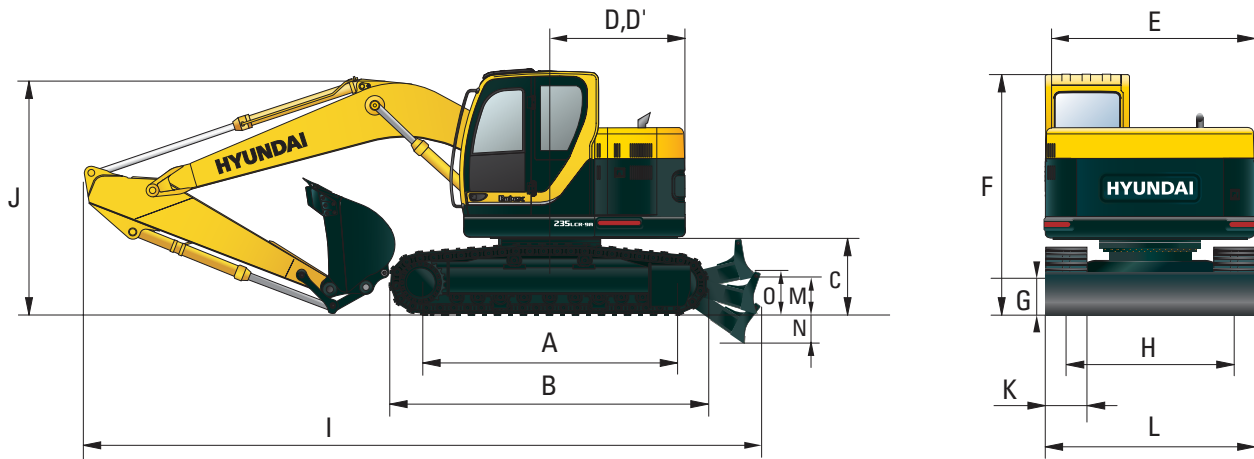

mm (ft-in)

A Tumbler distance	3,650 (11' 12")	Boom length	5,680 (18' 8")			
B Overall length of crawler	4,440 (14' 7")	Arm length	2,000 (6' 7")	2,400 (7' 10")	2,920 (9' 7")	
C Ground clearance of counterweight	1,060 (3' 6")	I Overall length	10,020 (32' 10")	9,930 (32' 7")	9,890 (32' 5")	
D Tail swing radius	1,780 (6' 04")	J Overall height of boom	3,200 (10' 6")	3,100 (10' 2")	3,020 (9' 11")	
D' Rear-end length	1,780 (6' 04")	K Track shoe width	600 (24")	700 (28")	800 (32")	900 (36")
E Overall width of upperstructure	2,980 (9' 9")	L Overall width	2990 (9' 10")	3,090 (10' 2")	3,190 (10' 6")	3,290 (10' 10")
F Overall height of cab	2,950 (9' 8")					
G Min. ground clearance	480 (1' 7")					
H Track gauge	2,390 (7' 10")					
M Ground clearance of blade up	575 (1' 11")					
N Depth of blade down	390 (1' 3")					
O Height of blade	710 (2' 4")					

## R235LCR-9A (DOZER TYPE) WORKING RANGE

mm (ft-in)

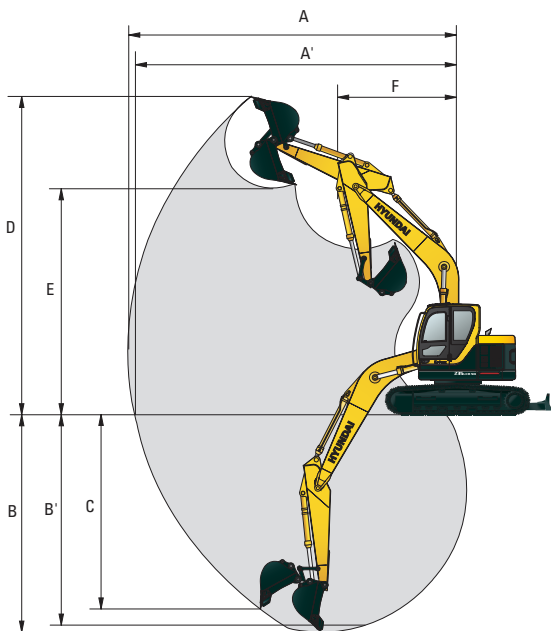

Boom length	5,680 (18' 8")		
Arm length	2,000 (6' 7")	2,400 (7' 10")	2,920 (9' 7")
A Max. digging reach	9,040 (29' 8")	9,430 (30' 11")	9,910 (32' 6")
A' Max. digging reach on ground	8,860 (29' 1")	9,260 (30' 5")	9,750 (31' 12")
B Max. digging depth	5,780 (18' 3")	6,180 (20' 3")	6,700 (21' 12")
B' Max. digging depth (8' level)	5,555 (18' 3")	5,980 (19' 7")	6,530 (21' 5")
C Max. vertical wall digging depth	5,140 (16' 10")	5,710 (18' 9")	6,270 (20' 7")
D Max. digging height	10,090 (33' 1")	10,420 (34' 2")	10,830 (35' 6")
E Max. dumping height	7,190 (23' 7")	7,510 (24' 8")	7,890 (25' 11")
F Min. swing radius	2,860 (9' 5")	2,550 (8' 4")	2,350 (7' 9")













# Lifting Capacity











## R235LCR-9A

 Rating over-front  Rating over-side or 360 degree











Boom : 5.68 m (18' 8") / Arm : 2.0 m (6' 7") / Bucket : 0.80 m<sup>3</sup> (1.05yd) SAE heaped / Shoe : 600mm(24") triple grouser

Load point height m (ft)		Load radius								At max. reach		
		3.0 m (10 ft)		4.5 m (15 ft)		6.0 m (20 ft)		7.5 m (25 ft)		Capacity		Reach m (ft)
												
10.5 m (35 ft)	kg									*4210	*4210	4.63
	lb									*9280	*9280	(15.2)
9.0 m (30 ft)	kg									*4630	*4630	4.48
	lb									*10210	*10210	(14.7)
7.5 m (25 ft)	kg			*4820	*4820					*4150	*4150	6.56
	lb			*10630	*10630					*9150	*9150	(21.5)
6.0 m (20 ft)	kg			*4980	*4980	*4590	*4590			*4050	3060	7.70
	lb			*10980	*10980	*10120	*10120			*8930	6750	(25.3)
4.5 m (15 ft)	kg	*8350	*8350	*5930	*5930	*4910	4570			*4050	2560	8.36
	lb	*18410	*18410	*13070	*13070	*10820	10080			*8930	5640	(27.4)
3.0 m (10 ft)	kg			*7310	6760	*5490	4310	*4620	2960	*4080	2320	8.67
	lb			*16120	14900	*12100	9500	*10190	6530	*8990	5110	(28.4)
1.5 m (5 ft)	kg			*8410	6250	*6040	4070	*4820	2860	*4130	2270	8.66
	lb			*18540	13780	*13320	8970	*10630	6310	*9110	5000	(28.4)
Ground Line	kg			*8720	6020	*6300	3910			*4150	2390	8.36
	lb			*19220	13270	*13890	8620			*9150	5270	(27.4)
-1.5 m (-5 ft)	kg	*11480	*11480	*8320	5980	*6110	3860			*4070	2760	7.69
	lb	*25310	*25310	*18340	13180	*13470	8510			*8970	6080	(25.2)
-3.0 m (-10 ft)	kg	*9710	*9710	*7190	6090	*5140	3950			*3660	3660	6.55
	lb	*21410	*21410	*15850	13430	*11330	8710			*8070	8070	(21.5)

Boom : 5.68 m (18' 8") / Arm : 2.40 m (7' 10") / Bucket : 0.80 m<sup>3</sup> (1.05 yd) SAE heaped / Shoe : 600mm(24") triple grouser

Load point height m (ft)		Load radius								At max. reach				
		1.5 m (5 ft)		3.0 m (10 ft)		4.5 m (15 ft)		6.0 m (20 ft)		7.5 m (25 ft)		Capacity		Reach m (ft)
														
9.0 m (30 ft)	kg											*4110	*4110	5.25
	lb											*9060	*9060	(17.2)
7.5 m (25 ft)	kg					*4280	*4280					*3820	3670	7.07
	lb					*9440	*9440					*8420	8090	(23.2)
6.0 m (20 ft)	kg					*4500	*4500	*4220	*4220			*3760	2780	8.12
	lb					*9920	*9920	*9300	*9300			*8290	6130	(26.6)
4.5 m (15 ft)	kg			*7270	*7270	*5450	*5450	*4600	*4600	*3950	3080	*3770	2350	8.74
	lb			*16030	*16030	*12020	*12020	*10140	*10140	*8710	6790	*8310	5180	(28.7)
3.0 m (10 ft)	kg			*11380	*11380	*6850	*6850	*5230	4350	*4420	2980	*3820	2150	9.04
	lb			*25090	*25090	*15100	*15100	*11530	9590	*9740	6570	*8420	4740	(29.7)
1.5 m (5 ft)	kg					*8100	6310	*5840	4080	*4690	2850	3850	2090	9.03
	lb					*17860	13910	*12870	8990	*10340	6280	8490	4610	(29.6)
Ground Line	kg			*9120	*9120	*8640	6000	*6210	3890	*4820	2750	*3930	2190	8.74
	lb			*20110	*20110	*19050	13230	*13690	8580	*10630	6060	*8660	4830	(28.7)
-1.5 m (-5 ft)	kg	*9720	*9720	*12220	11860	*8450	5920	*6160	3810			*3900	2490	8.12
	lb	*21430	*21430	*26940	26150	*18630	13050	*13580	8400			*8600	5490	(26.6)
-3.0 m (-10 ft)	kg	*14180	*14180	*10550	*10550	*7550	5990	*5480	3850			*3650	3190	7.06
	lb	*31260	*31260	*23260	*23260	*16640	13210	*12080	8490			*8050	7030	(23.2)
-4.5 m (-15 ft)	kg			*7670	*7670	*5530	*5530							
	lb			*16910	*16910	*12190	*12190							

Boom : 5.68 m (18' 8") / Arm : 2.92 m (9' 7") / Bucket : 0.80 m<sup>3</sup> (1.05 yd) SAE heaped / Shoe : 600mm(24") triple grouser

Load point height m (ft)		Load radius								At max. reach				
		1.5 m (5 ft)		3.0 m (10 ft)		4.5 m (15 ft)		6.0 m (20 ft)		7.5 m (25 ft)		Capacity		Reach m (ft)
														
9.0 m (30 ft)	kg					*2970	*2970					*3630	*3630	6.12
	lb					*6550	*6550					*8000	*8000	(20.1)
7.5 m (25 ft)	kg							*3310	*3310			*3460	3180	7.70
	lb							*7300	*7300			*7630	7010	(25.3)
6.0 m (20 ft)	kg							*3780	*3780			*3430	2480	8.66
	lb							*8330	*8330			*7560	5470	(28.4)
4.5 m (15 ft)	kg					*4810	*4810	*4190	*4190	*3860	3140	*3460	2120	9.24
	lb					*10600	*10600	*9240	*9240	*8510	6920	*7630	4670	(30.3)
3.0 m (10 ft)	kg			*9730	*9730	*6240	*6240	*4860	4410	*4150	3000	*3520	1940	9.52
	lb			*21450	*21450	*13760	*13760	*10710	9720	*9150	6610	*7760	4280	(31.2)
1.5 m (5 ft)	kg			*9500	*9500	*7650	6410	*5560	4110	*4490	2850	3520	1890	9.52
	lb			*20940	*20940	*16870	14130	*12260	9060	*9900	6280	7760	4170	(31.2)
Ground Line	kg			*9890	*9890	*8460	6010	*6050	3880	*4720	2730	*3650	1960	9.24
	lb			*21800	*21800	*18650	13250	*13340	8550	*10410	6020	*8050	4320	(30.3)
-1.5 m (-5 ft)	kg	*8800	*8800	*12860	11680	*8530	5850	*6160	3760	*4690	2660	*3670	2190	8.66
	lb	*19400	*19400	*28350	25750	*18810	12900	*13580	8290	*10340	5860	*8090	4830	(28.4)
-3.0 m (-10 ft)	kg	*12230	*12230	*11440	*11440	*7900	5870	*5740	3750			*3560	2720	7.69
	lb	*26960	*26960	*25220	*25220	*17420	12940	*12650	8270			*7850	6000	(25.2)
-4.5 m (-15 ft)	kg			*8990	*8990	*6360	6050					*2980	2980	6.11
	lb			*19820	*19820	*14020	13340					*6570	*6570	(20.0)











- Lifting capacity is based on SAE J1097, ISO 10567.
- Lifting capacity of the Robex Series does not exceed 75% of the tipping load with the machine on firm, level ground or 87% of full hydraulic capacity.
- The load point is a hook located on the back of the bucket.
- (\*) indicates the load limited by hydraulic capacity.

# Lifting Capacity











## R235LCR-9A (DOZER TYPE)

 Rating over-front  Rating over-side or 360 degree

Boom : 5.68 m (18' 8") / Arm : 2.0 m (6' 7") / Bucket : 0.80 m<sup>3</sup> (1.05yd<sup>3</sup>) SAE heaped / Shoe : 600mm(24") triple grouser, Dozer blade Down

Load point height m (ft)		Load radius								At max. reach		Reach m (ft)
		3.0 m (10 ft)		4.5 m (15 ft)		6.0 m (20 ft)		7.5 m (25 ft)		Capacity		
												
10.5 m	kg									*4210	*4210	4.63
(35 ft)	lb									*9280	*9280	(15.2)
9.0 m	kg									*4630	*4630	4.48
(30 ft)	lb									*10210	*10210	(14.7)
7.5 m	kg			*4820	*4820					*4150	*4150	6.56
(25 ft)	lb			*10630	*10630					*9150	*9150	(21.5)
6.0 m	kg			*4980	*4980	*4590	*4590			*4050	3460	7.70
(20 ft)	lb			*10980	*10980	*10120	*10120			*8930	7630	(25.3)
4.5 m	kg	*8350	*8350	*5930	*5930	*4910	*4910			*4050	2920	8.36
(15 ft)	lb	*18410	*18410	*13070	*13070	*10820	*10820			*8930	6440	(27.4)
3.0 m	kg			*7310	*7310	*5490	4890	*4620	3380	*4080	2670	8.67
(10 ft)	lb			*16120	*16120	*12100	10780	*10190	7450	*8990	5890	(28.4)
1.5 m	kg			*8410	7130	*6040	4640	*4820	3280	*4130	2620	8.66
(5 ft)	lb			*18540	15720	*13320	10230	*10630	7230	*9110	5780	(28.4)
Ground	kg			*8720	6900	*6300	4480			*4150	2760	8.36
Line	lb			*19220	15210	*13890	9880			*9150	6080	(27.4)
-1.5 m	kg	*11480	*11480	*8320	6860	*6110	4430			*4070	3160	7.69
(-5 ft)	lb	*25310	*25310	*18340	15120	*13470	9770			*8970	6970	(25.2)
-3.0 m	kg	*9710	*9710	*7190	6980	*5140	4520			*3660	*3660	6.55
(-10 ft)	lb	*21410	*21410	*15850	15390	*11330	9960			*8070	*8070	(21.5)

Boom : 5.68 m (18' 8") / Arm : 2.0 m (6' 7") / Bucket : 0.80 m<sup>3</sup> (1.05yd<sup>3</sup>) SAE heaped / Shoe : 600mm(24") triple grouser, Dozer blade Up

Load point height m (ft)		Load radius								At max. reach		Reach m (ft)
		3.0 m (10 ft)		4.5 m (15 ft)		6.0 m (20 ft)		7.5 m (25 ft)		Capacity		
												
10.5 m	kg									*4210	*4210	4.63
(35 ft)	lb									*9280	*9280	(15.2)
9.0 m	kg									*4630	*4630	4.48
(30 ft)	lb									*10210	*10210	(14.7)
7.5 m	kg			*4820	*4820					*4150	*4150	6.56
(25 ft)	lb			*10630	*10630					*9150	*9150	(21.5)
6.0 m	kg			*4980	*4980	*4590	*4590			*4050	3250	7.70
(20 ft)	lb			*10980	*10980	*10120	*10120			*8930	7170	(25.3)
4.5 m	kg	*8350	*8350	*5930	*5930	*4910	4830			*4050	2730	8.36
(15 ft)	lb	*18410	*18410	*13070	*13070	*10820	10650			*8930	6020	(27.4)
3.0 m	kg			*7310	7140	*5490	4570	*4620	3160	*4080	2490	8.67
(10 ft)	lb			*16120	15740	*12100	10080	*10190	6970	*8990	5490	(28.4)
1.5 m	kg			*8410	6630	*6040	4330	*4820	3050	*4060	2440	8.66
(5 ft)	lb			*18540	14620	*13320	9550	*10630	6720	8950	5380	(28.4)
Ground	kg			*8720	6400	*6300	4170			*4150	2570	8.36
Line	lb			*19220	14110	*13890	9190			*9150	5670	(27.4)
-1.5 m	kg	*11480	*11480	*8320	6360	*6110	4120			*4070	2950	7.69
(-5 ft)	lb	*25310	*25310	*18340	14020	*13470	9080			*8970	6500	(25.2)
-3.0 m	kg	*9710	*9710	*7190	6470	*5140	4210			*3660	*3660	6.55
(-10 ft)	lb	*21410	*21410	*15850	14260	*11330	9280			*8070	*8070	(21.5)













- Lifting capacity is based on SAE J1097, ISO 10567.
- Lifting capacity of the Robex Series does not exceed 75% of the tipping load with the machine on firm, level ground or 87% of full hydraulic capacity.
- The load point is a hook located on the back of the bucket.
- (\*) indicates the load limited by hydraulic capacity.

# Lifting Capacity













## R235LCR-9A (DOZER TYPE)

 Rating over-front  Rating over-side or 360 degree

Boom : 5.68 m (18' 8") / Arm : 2.40 m (7' 10") / Bucket : 0.80 m<sup>3</sup> (1.05 yd) SAE heaped / Shoe : 600mm(24") triple grouser, Dozer blade Down

Load point height m (ft)		Load radius										At max. reach			
		1.5 m (5 ft)		3.0 m (10 ft)		4.5 m (15 ft)		6.0 m (20 ft)		7.5 m (25 ft)		Capacity		Reach m (ft)	
															
9.0 m (30 ft)	kg												*4110	*4110	5.25 (17.2)
7.5 m (25 ft)	kg					*4280	*4280						*9060	*9060	7.07 (23.2)
6.0 m (20 ft)	kg					*9440	*9440						*3820	*3820	8.12 (26.6)
6.0 m (20 ft)	lb					*4500	*4500	*4220	*4220				*8420	*8420	3160 (9.04)
4.5 m (15 ft)	kg					*9920	*9920	*9300	*9300				*3760	*3760	2700 (8.74)
4.5 m (15 ft)	lb					*7270	*7270	*5450	*5450	*4600	*4600	*3950	3510	3170	2700 (8.74)
3.0 m (10 ft)	kg					*16030	*16030	*12020	*12020	*10140	*10140	*8710	7740	*8310	5950 (28.7)
3.0 m (10 ft)	lb					*11380	*11380	*6850	*6850	*5230	4920	*4420	3400	*3820	2480 (9.04)
1.5 m (5 ft)	kg					*25090	*25090	*15100	*15100	*11530	10850	*9740	7500	*8420	5470 (29.7)
1.5 m (5 ft)	lb					*8100	7190	*5840	4650	*4690	3270	*3880	2420	*3880	2420 (9.03)
Ground Line	kg					*17860	15850	*12870	10250	*10340	7210	*8550	5340	*8550	5340 (29.6)
Ground Line	lb					*8640	6880	*6210	4460	*4820	3170	*3930	2530	*3930	2530 (8.74)
-1.5 m (-5 ft)	kg	*9720	*9720	*12220	*12220	*19050	15170	*13690	9830	*10630	6990	*8660	5580	*8660	5580 (28.7)
-1.5 m (-5 ft)	lb	*21430	*21430	*26940	*26940	*8450	6790	*6160	4370	*3900	2870	*3900	2870	*3900	2870 (8.12)
-3.0 m (-10 ft)	kg	*14180	*14180	*10550	*10550	*18630	14970	*13580	9630	*8600	6330	*8600	6330	*8600	6330 (26.6)
-3.0 m (-10 ft)	lb	*31260	*31260	*23260	*23260	*7550	6870	*5480	4420	*3650	3650	*3650	3650	*3650	3650 (7.06)
-4.5 m (-15 ft)	kg					*16910	*16910	*12190	*12190						
-4.5 m (-15 ft)	lb					*16910	*16910	*12190	*12190						

Boom : 5.68 m (18' 8") / Arm : 2.40 m (7' 10") / Bucket : 0.80 m<sup>3</sup> (1.05 yd) SAE heaped / Shoe : 600mm(24") triple grouser, Dozer blade Up

Load point height m (ft)		Load radius										At max. reach				
		1.5 m (5 ft)		3.0 m (10 ft)		4.5 m (15 ft)		6.0 m (20 ft)		7.5 m (25 ft)		Capacity		Reach m (ft)		
																
9.0 m (30 ft)	kg													*4110	*4110	5.25 (17.2)
7.5 m (25 ft)	kg					*4280	*4280							*9060	*9060	7.07 (23.2)
6.0 m (20 ft)	kg					*9440	*9440							*3820	*3820	8.12 (26.6)
6.0 m (20 ft)	lb					*4500	*4500	*4220	*4220					*8420	*8420	3160 (9.04)
4.5 m (15 ft)	kg					*9920	*9920	*9300	*9300					*3760	*3760	2960 (8.12)
4.5 m (15 ft)	lb					*7270	*7270	*5450	*5450	*4600	*4600	*3950	3280	*8290	6530 (26.6)	
3.0 m (10 ft)	kg					*16030	*16030	*12020	*12020	*10140	*10140	*8710	7230	*8310	5560 (28.7)	
3.0 m (10 ft)	lb					*11380	*11380	*6850	*6850	*5230	4610	*4420	3170	*3820	2300 (9.04)	
1.5 m (5 ft)	kg					*25090	*25090	*15100	*15100	*11530	10160	*9740	6990	*8420	5070 (29.7)	
1.5 m (5 ft)	lb					*8100	6690	*5840	4340	*4690	3050	*3780	2250	*3780	2250 (9.03)	
Ground Line	kg					*17860	14750	*12870	9570	*10340	6720	*8330	4960	*8330	4960 (29.6)	
Ground Line	lb					*8640	6380	*6210	4150	*4820	2950	*3930	2360	*3930	2360 (8.74)	
-1.5 m (-5 ft)	kg	*9720	*9720	*12220	*12220	*19050	14070	*13690	9150	*10630	6500	*8660	5200	*8660	5200 (28.7)	
-1.5 m (-5 ft)	lb	*21430	*21430	*26940	*26940	*8450	6300	*6160	4070	*3900	2670	*3900	2670	*3900	2670 (8.12)	
-3.0 m (-10 ft)	kg	*14180	*14180	*10550	*10550	*18630	13890	*13580	8970	*8600	5890	*8600	5890	*8600	5890 (26.6)	
-3.0 m (-10 ft)	lb	*31260	*31260	*23260	*23260	*7550	6370	*5480	4110	*3650	3410	*3650	3410	*3650	3410 (7.06)	
-4.5 m (-15 ft)	kg					*16910	*16910	*12190	*12190					*8050	7520	(23.2)
-4.5 m (-15 ft)	lb					*16910	*16910	*12190	*12190					*8050	7520	(23.2)













- Lifting capacity is based on SAE J1097, ISO 10567.
- Lifting capacity of the Robex Series does not exceed 75% of the tipping load with the machine on firm, level ground or 87% of full hydraulic capacity.
- The load point is a hook located on the back of the bucket.
- (\* ) indicates the load limited by hydraulic capacity.

# Lifting Capacity













## R235LCR-9A (DOZER TYPE)

 Rating over-front  Rating over-side or 360 degree

Boom : 5.68 m (18' 8") / Arm : 2.92 m (9' 7") / Bucket : 0.80 m<sup>3</sup> (1.05 yd<sup>3</sup>) SAE heaped / Shoe : 600mm(24") triple grouser, Dozer blade Down

Load point height m (ft)		Load radius										At max. reach		
		1.5 m (5 ft)		3.0 m (10 ft)		4.5 m (15 ft)		6.0 m (20 ft)		7.5 m (25 ft)		Capacity		Reach m (ft)
														
9.0 m (30 ft)	kg lb					*2970 *6550	*2970 *6550					*3630 *8000	*3630 *8000	6.12 (20.1)
7.5 m (25 ft)	kg lb							*3310 *7300	*3310 *7300			*3460 *7630	*3460 *7630	7.70 (25.3)
6.0 m (20 ft)	kg lb							*3780 *8330	*3780 *8330			*3430 *7560	*2830 6240	8.66 (28.4)
4.5 m (15 ft)	kg lb					*4810 *10600	*4810 *10600	*4190 *9240	*4190 *9240	*3860 *8510	3560 7850	*3460 *7630	2440 5380	9.24 (30.3)
3.0 m (10 ft)	kg lb			*9730 *21450	*9730 *21450	*6240 *13760	*6240 *13760	*4860 *10710	*4860 *10710	*4150 *9150	3420 7540	*3520 *7760	2250 4960	9.52 (31.2)
1.5 m (5 ft)	kg lb			*9500 *20940	*9500 *20940	*7650 *16870	7300 16090	*5560 *12260	4680 10320	*4490 *9900	3270 7210	*3590 *7910	2200 4850	9.52 (31.2)
Ground Line	kg lb			*9890 *21800	*9890 *21800	*8460 *18650	6890 15190	*6050 *13340	4450 9810	*4720 *10410	3140 6920	*3650 *8050	2280 5030	9.24 (30.3)
-1.5 m (-5 ft)	kg lb	*8800 *19400	*8800 *19400	*12860 *28350	*12860 *28350	*8530 *18810	6730 14840	*6160 *13580	4320 9520	*4690 *10340	3080 6790	*3670 *8090	2540 5600	8.66 (28.4)
-3.0 m (-10 ft)	kg lb	*12230 *26960	*12230 *26960	*11440 *25220	*11440 *25220	*7900 *17420	6750 14880	*5740 *12650	4320 9520			*3560 *7850	3120 6880	7.69 (25.2)
-4.5 m (-15 ft)	kg lb			*8990 *19820	*8990 *19820	*6360 *14020	*6360 *14020					*2980 *6570	*2980 *6570	6.11 (20.0)

Boom : 5.68 m (18' 8") / Arm : 2.92 m (9' 7") / Bucket : 0.80 m<sup>3</sup> (1.05 yd<sup>3</sup>) SAE heaped / Shoe : 600mm(24") triple grouser, Dozer blade Up

Load point height m (ft)		Load radius										At max. reach		
		1.5 m (5 ft)		3.0 m (10 ft)		4.5 m (15 ft)		6.0 m (20 ft)		7.5 m (25 ft)		Capacity		Reach m (ft)
														
9.0 m (30 ft)	kg lb					*2970 *6550	*2970 *6550					*3630 *8000	*3630 *8000	6.12 (20.1)
7.5 m (25 ft)	kg lb							*3310 *7300	*3310 *7300			*3460 *7630	*3370 7430	7.70 (25.3)
6.0 m (20 ft)	kg lb							*3780 *8330	*3780 *8330			*3430 *7560	*2650 5840	8.66 (28.4)
4.5 m (15 ft)	kg lb					*4810 *10600	*4810 *10600	*4190 *9240	*4190 *9240	*3860 *8510	3330 7340	*3460 *7630	2270 5000	9.24 (30.3)
3.0 m (10 ft)	kg lb			*9730 *21450	*9730 *21450	*6240 *13760	*6240 *13760	*4860 *10710	4670 10300	*4150 *9150	3200 7050	3510 7740	2090 4610	9.52 (31.2)
1.5 m (5 ft)	kg lb			*9500 *20940	*9500 *20940	*7650 *16870	6790 14970	*5560 *12260	4370 9630	*4490 *9900	3050 6720	3450 7610	2040 4500	9.52 (31.2)
Ground Line	kg lb			*9890 *21800	*9890 *21800	*8460 *18650	6390 14090	*6050 *13340	4140 9130	*4720 *10410	2920 6440	3590 7910	2120 4670	9.24 (30.3)
-1.5 m (-5 ft)	kg lb	*8800 *19400	*8800 *19400	*12860 *28350	12390 27320	*8530 *18810	6240 13760	*6160 *13580	4020 8860	*4690 *10340	2860 6310	*3670 *8090	2360 5200	8.66 (28.4)
-3.0 m (-10 ft)	kg lb	*12230 *26960	*12230 *26960	*11440 *25220	*11440 *25220	*7900 *17420	6250 13780	*5740 *12650	4010 8840			*3560 *7850	2910 6420	7.69 (25.2)
-4.5 m (-15 ft)	kg lb			*8990 *19820	*8990 *19820	*6360 *14020	*6360 *14020					*2980 *6570	*2980 *6570	6.11 (20.0)

- Lifting capacity is based on SAE J1097, ISO 10567.
- Lifting capacity of the Robex Series does not exceed 75% of the tipping load with the machine on firm, level ground or 87% of full hydraulic capacity.
- The load point is a hook located on the back of the bucket.
- (\*) indicates the load limited by hydraulic capacity.